

CUSTOMER : \_\_\_\_\_.

DATE : \_\_\_\_\_.

REV : \_\_\_\_\_.

# PRODUCT FAMILY DATA SHEET

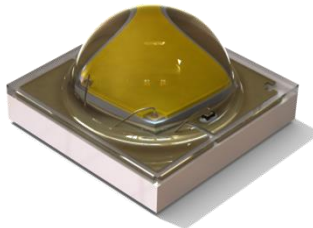

## Top View Type White SMD LED

MODEL NAME : LEMW A33X◇◇◇◇◇◇◇◇◇◇

**RoHS**  
Compliant

**Halogen**  
Compliant

APPROVAL	REMARK	APPENDIX

DESIGNED	CHECKED	APPROVED

## TABLE OF CONTENTS

1. Features	-----	2
2. Applications	-----	2
3. Outline Dimensions	-----	2
4. Absolute Maximum Ratings	-----	3
5. Electro-Optical Characteristics	-----	3~5
6. Flux Bins and Order Code	-----	6~7
7. Chromaticity Bins	-----	8~10
8. Typical Characteristic Curves	-----	11~18
9. Reliability Test Items and Conditions	-----	19
10. Packing and Labeling of Products	-----	20~23
11. Cautions on Use	-----	24~27
12. Disclaimers	-----	27
13. Package Nomenclature	-----	28
Change History of Revision	-----	29

## 1. Features

- Lighting Color : White
- Lead Frame Type LED Package : 3.40 x 3.40 x 2.37 (L x W x H) [Unit : mm]
- Viewing Angle : 120°
- Chip Material : InGaN
- Soldering Methods : Reflow soldering
- ESD Withstand Voltage : Up to 8kV According to JESD22-A 114

## 2. Applications

- Interior and Exterior Illumination

## 3. Outline Dimensions

( Unit : mm )

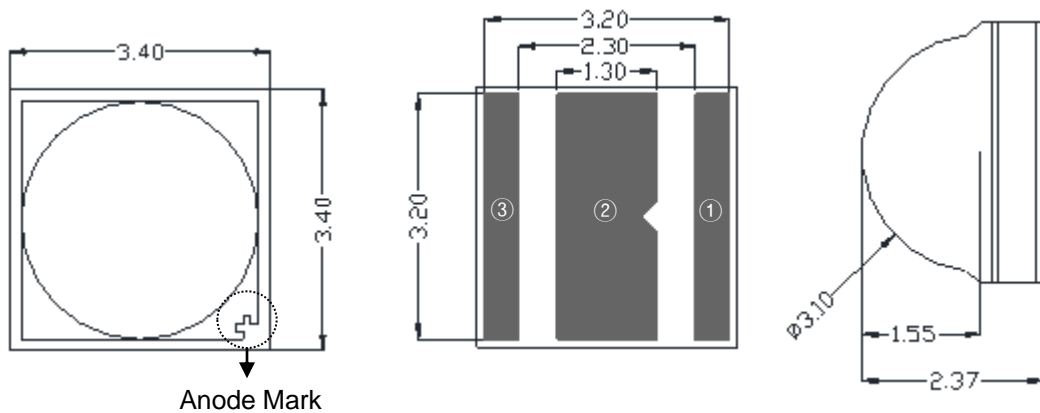

### Recommendable Soldering Pattern (for Reflow Soldering)

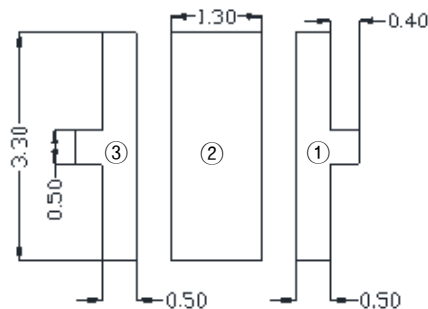
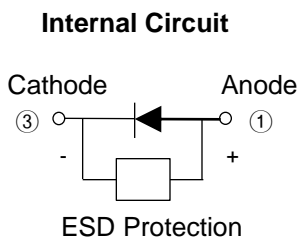

### Pad Configuration

- ① Anode Pad
- ② Thermal Pad
- ③ Cathode Pad

Tolerances unless otherwise mentioned are  $\pm 0.13$  mm

## 4. Absolute Maximum Ratings

(Ta=25°C)

Item	Symbol	Rating	Unit
Forward Current	I <sub>f</sub>	1500	mA
Operating Temperature	T <sub>opr</sub>	-40 ~ +105	°C
Storage Temperature	T <sub>stg</sub>	-40 ~ +125	°C
Junction Temperature	T <sub>j</sub>	150	°C
Soldering Temperature	JEDEC-J-STD-020D		
ESD Classification	Class 3B (JESD22-A114)		

- ※ Operating the LED beyond the listed maximum ratings may affect device reliability and cause permanent damage. These or any other conditions beyond those indicated under recommended operating conditions are not implied. The exposure to the absolute maximum rated conditions may affect device reliability.
- ※ The LEDs are not designed to be driven in reverse bias.

## 5. Electro - Optical Characteristics

Item		Symbol	Condition	Min.	Typ.	Max.	Unit
Luminous Flux	Cool + CRI 70, 75	Φ <sub>v</sub>	I <sub>F</sub> = 350mA	132	Refer to 'Flux Bins'		lm
	Neutral + CRI 70			132			
	Warm + CRI 80			115			
Forward Voltage		V <sub>f</sub>	I <sub>F</sub> = 350mA	2.70	2.80	3.10	V
Color Coordinate		C <sub>x</sub> / C <sub>y</sub>	T <sub>j</sub> = 85°C	Refer to 'Chromaticity Bins'			-
Color Rendering Index (CRI)		Ra		70	-	-	
				80	-	-	
				90	-	-	
Viewing Angle		2Θ1/2		-	120	-	deg
Thermal Resistance, Junction to Solder		R <sub>th j-s</sub>	I <sub>F</sub> = 350mA	-	4	-	°C/W
Temperature Coefficient of Forward Voltage <sup>*1)</sup>		ΔV <sub>f</sub> / ΔT <sub>j</sub>		-1.0	-	-4.0	mV/°C

\*1) Measured at Ta between 25°C and 150°C.

※ These values are measured by the LG Innotek optical spectrum analyzer within the following tolerances. Luminous Flux (Φ<sub>v</sub>) : ±7%, Forward Voltage (V<sub>f</sub>) : ±0.1V, Color Value : ±0.005, CRI Value : ±2,

※ Although all LEDs are tested by LG Innotek equipment, some values may vary slightly depending on the conditions of the test equipment.

5. Electro - Optical Characteristics (Continued)

(T<sub>j</sub>=85°C)

CCT	CRI	I <sub>f</sub> (mA)	V <sub>f</sub> (V)	Power (W)	Φ <sub>v</sub> (lm)	lm/W
4500~6500K (Cool White)	70	350	2.79	0.98	171	176
		700	2.93	2.05	311	152
		1,000	3.04	3.04	414	136
		1,500	3.21	4.82	560	116
	75	350	2.79	0.98	160	164
		700	2.93	2.05	291	142
		1,000	3.04	3.04	387	127
		1,500	3.21	4.82	523	109
	80	350	2.79	0.98	156	160
		700	2.93	2.05	284	138
		1,000	3.04	3.04	378	124
		1,500	3.21	4.82	511	106
4000K (Neutral White)	70	350	2.79	0.98	160	163
		700	2.93	2.05	288	140
		1,000	3.04	3.04	384	126
		1,500	3.21	4.82	516	107
	80	350	2.79	0.98	150	154
		700	2.93	2.05	270	132
		1000	3.04	3.04	359	118
		1500	3.21	4.82	486	101
3500K 3000K (Warm White)	70	350	2.79	0.98	154	157
		700	2.93	2.05	276	135
		1,000	3.04	3.04	365	120
		1,500	3.21	4.82	490	102
	80	350	2.79	0.98	144	148
		700	2.93	2.05	259	126
		1,000	3.04	3.04	342	113
		1,500	3.21	4.82	460	95
	90	350	2.79	0.98	125	128
		700	2.93	2.05	225	110
		1,000	3.04	3.04	297	98
		1,500	3.21	4.82	399	83

5. Electro - Optical Characteristics (Continued)

( Ta=25°C)

CCT	CRI	If (mA)	Vf (V)	Power (W)	Φv (lm)	lm/W
4500~6500K (Cool White)	70	350	2.89	1.01	182	180
		700	3.04	2.13	333	156
		1,000	3.16	3.16	448	142
		1,500	3.34	5.01	616	123
	75	350	2.89	0.98	170	168
		700	3.04	2.05	311	146
		1,000	3.16	3.04	418	132
		1,500	3.34	4.82	576	115
	80	350	2.89	1.01	166	164
		700	3.04	2.13	304	143
		1,000	3.16	3.16	408	129
		1,500	3.34	5.01	562	112
4000K (Neutral White)	70	350	2.89	1.01	170	168
		700	3.04	2.13	309	145
		1,000	3.16	3.16	414	131
		1,500	3.34	5.01	569	114
	80	350	2.89	1.01	158	156
		700	3.04	2.13	284	134
		1000	3.16	3.16	381	120
		1500	3.34	5.01	520	104
3500K 3000K (Warm White)	70	350	2.89	1.01	162	160
		700	3.04	2.13	291	137
		1,000	3.16	3.16	388	123
		1,500	3.34	5.01	527	105
	80	350	2.89	1.01	152	150
		700	3.04	2.13	273	129
		1,000	3.16	3.16	364	115
		1,500	3.34	5.01	495	99
	90	350	2.89	1.01	132	130
		700	3.04	2.13	238	112
		1,000	3.16	3.16	316	100
		1,500	3.34	5.01	429	86

## 6. Flux Bins and Order Code

(T<sub>j</sub> = 85 °C / T<sub>a</sub>=25 °C)

CRI	CCT (Color)	Luminous Flux [lm]							Order Code
		Bin Code	@350mA, 25 °C		@350mA, 85 °C		@700mA, 85 °C		
			Min.	Max.	Min.	Max.	Min.	Max.	
70	6500K	X6	139	148	132	141	239	255	LEMWA33X70FX****
		X7	148	156	141	148	255	268	
	5700K	X8	156	164	148	156	268	283	LEMWA33X70GX****
	5000K	X8	156	164	148	156	268	283	LEMWA33X70HX****
	4500K	X9	164	172	156	163	283	296	LEMWA33X70IX****
	4000K	XA	172	181	163	172	296	311	LEMWA33X70JX****
	3000K	XB	181	191	172	181	311	327	LEMWA33X70LX****
75	6500K	X6	139	148	132	141	239	255	LEMWA33X75FX****
		X7	148	156	141	148	255	268	
	5700K	X8	156	164	148	156	268	283	LEMWA33X75GX****
	5000K	X9	164	172	156	163	283	296	LEMWA33X75HX****
		XA	172	181	163	172	296	311	
80	5700K	X4	122	130	115	124	209	224	LEMWA33X80GX****
	5000K	X5	130	139	124	132	224	239	LEMWA33X80HX****
	4000K	X6	139	148	132	141	239	255	LEMWA33X80JX****
	3500K	X7	148	156	141	148	255	268	LEMWA33X80KX****
	3000K		148	156	141	148	255	268	LEMWA33X80LX****
	3000K	X8	156	164	148	156	268	283	LEMWA33X80MX****
	2700K		156	164	148	156	268	283	
90	5300K	X4	122	130	115	124	209	224	LEMWA33X90SX****
	4000K	X5	130	139	124	132	224	239	LEMWA33X90JX****
	3000K	X6	139	148	132	141	239	255	LEMWA33X90LX****

## 6. Flux Bins and Order Code

▪ Flux Bins (@350mA)

Min CRI [Ra]	Typ CCT [K]	Sortation	Flux Bins								
			Rank	X4	X5	X6	X7	X8	X9	XA	XB
		T <sub>j</sub> = 85 °C	115-124	124-132	132-141	141-148	148-156	156-163	163-172	172-181	
		T <sub>a</sub> = 25 °C	122-130	130-139	139-148	148-156	156-164	164-172	172-181	181-191	
70	6500	70F			X6	X7	X8	X9	XA		
70	5700	70G				X7	X8	X9	XA	XB	
70	5000	70H				X7	X8	X9	XA	XB	
70	4500	70I				X7	X8	X9	XA	XB	
70	4000	70J			X6	X7	X8	X9	XA		
70	3000	70L			X6	X7	X8	X9			
75	6500	75F			X6	X7	X8	X9			
75	5700	75G			X6	X7	X8	X9	XA		
75	5000	75H			X6	X7	X8	X9	XA		
80	5700	80G			X6	X7	X8	X9			
80	5000	80H			X6	X7	X8	X9			
80	4000	80J		X5	X6	X7	X8				
80	3500	80K	X4	X5	X6	X7					
80	3000	80L	X4	X5	X6	X7					
80	2700	80M	X4	X5	X6						
90	5300	90S	X4	X5	X6	X7					
90	4000	90J	X4	X5	X6						
90	3000	90L	X4	X5							

▪ Forward Voltage Bins

Bin	V <sub>f</sub> (V) @350mA, 85 °C		V <sub>f</sub> (V) @350mA, 25 °C	
	Min.	Max.	Min.	Max.
9	2.70	2.80	2.80	2.90
0	2.80	2.90	2.90	3.00
1	2.90	3.00	3.00	3.10
2	3.00	3.10	3.10	3.20



## 7. Chromaticity Bins

LG Innotek complies with the ANSI C78.377A standard for its chromaticity bin structure. For each ANSI quadrangle for the CCT range of 4500K to 6500K, LG Innotek provides 4 micro bins.

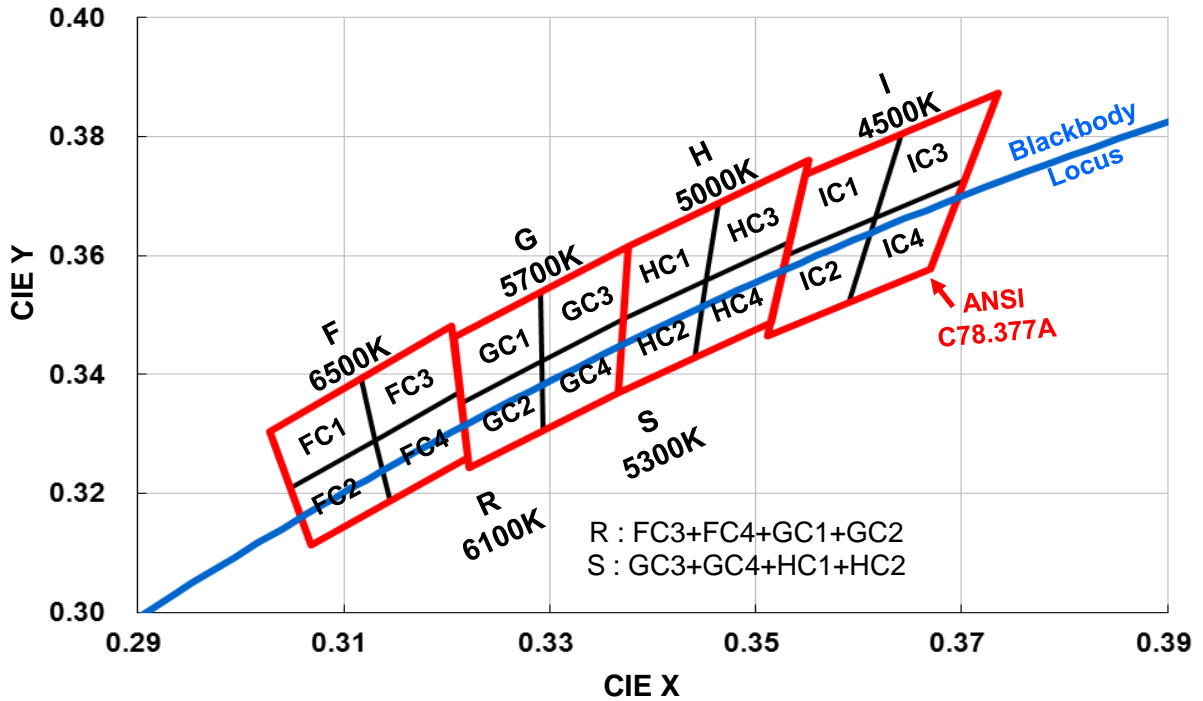

Bin	CIE X	CIE Y	Bin	CIE X	CIE Y	Bin	CIE X	CIE Y	Bin	CIE X	CIE Y
FC1	0.3028	0.3304	GC1	0.3207	0.3462	HC1	0.3376	0.3616	IC1	0.3548	0.3736
	0.3117	0.3393		0.3292	0.3539		0.3464	0.3688		0.3642	0.3805
	0.3131	0.3290		0.3293	0.3423		0.3452	0.3558		0.3617	0.3663
	0.3048	0.3209		0.3215	0.3353		0.3371	0.3493		0.3530	0.3601
FC2	0.3048	0.3209	GC2	0.3215	0.3353	HC2	0.3371	0.3493	IC2	0.3530	0.3601
	0.3131	0.3290		0.3293	0.3423		0.3452	0.3558		0.3617	0.3663
	0.3145	0.3187		0.3294	0.3306		0.3441	0.3428		0.3591	0.3522
	0.3068	0.3113		0.3222	0.3243		0.3366	0.3369		0.3512	0.3465
FC3	0.3117	0.3393	GC3	0.3292	0.3539	HC3	0.3464	0.3688	IC3	0.3642	0.3805
	0.3205	0.3481		0.3376	0.3616		0.3551	0.3760		0.3736	0.3874
	0.3213	0.3371		0.3371	0.3493		0.3533	0.3624		0.3703	0.3726
	0.3131	0.3290		0.3293	0.3423		0.3452	0.3558		0.3617	0.3663
FC4	0.3131	0.3290	GC4	0.3293	0.3423	HC4	0.3452	0.3558	IC4	0.3617	0.3663
	0.3213	0.3371		0.3371	0.3493		0.3533	0.3624		0.3703	0.3726
	0.3221	0.3261		0.3366	0.3369		0.3515	0.3487		0.3670	0.3578
	0.3145	0.3187		0.3294	0.3306		0.3441	0.3428		0.3591	0.3522

## 7. Chromaticity Bins (Continued)

LG Innotek complies with the ANSI C78.377A standard for its chromaticity bin structure. For each ANSI quadrangle for the CCT range of 2700K to 4000K, LG Innotek provides 16 micro bins.

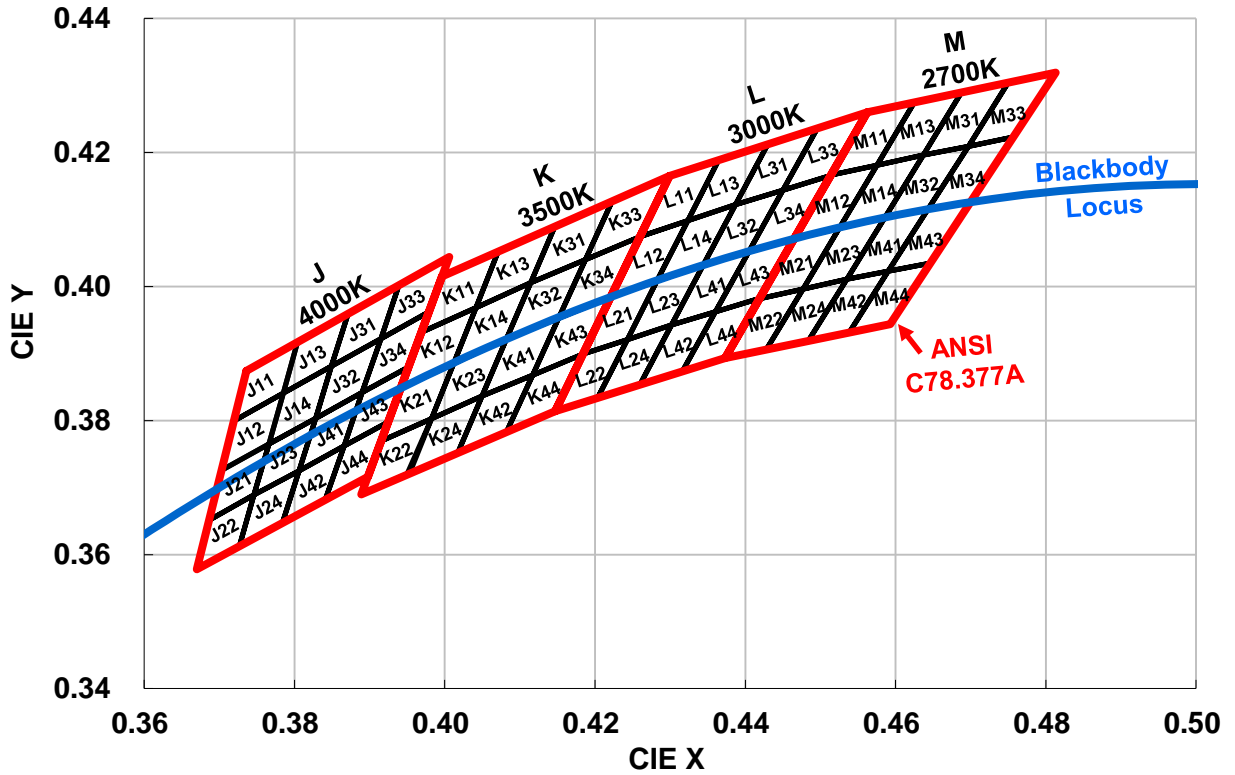

Bin	CIE X	CIE Y	Bin	CIE X	CIE Y	Bin	CIE X	CIE Y	Bin	CIE X	CIE Y
J11	0.3736	0.3874	K11	0.3996	0.4015	L11	0.4299	0.4165	M11	0.4562	0.4260
	0.3804	0.3917		0.4071	0.4052		0.4364	0.4189		0.4625	0.4275
	0.3785	0.3841		0.4041	0.3969		0.4323	0.4098		0.4575	0.4181
J12	0.3720	0.3800	K12	0.3969	0.3932	L12	0.4260	0.4075	M12	0.4513	0.4166
	0.3785	0.3841		0.4041	0.3969		0.4323	0.4098		0.4575	0.4181
	0.3766	0.3765		0.4012	0.3885		0.4282	0.4008		0.4525	0.4087
J13	0.3703	0.3726	K13	0.3941	0.3848	L13	0.4221	0.3984	M13	0.4465	0.4071
	0.3804	0.3917		0.4071	0.4052		0.4364	0.4189		0.4625	0.4275
	0.3871	0.3959		0.4146	0.4089		0.4430	0.4212		0.4687	0.4289
J14	0.3849	0.3881	K14	0.4114	0.4005	L14	0.4387	0.4122	M14	0.4637	0.4196
	0.3785	0.3841		0.4041	0.3969		0.4323	0.4098		0.4575	0.4181
	0.3849	0.3881		0.4114	0.4005		0.4387	0.4122		0.4637	0.4196
	0.3828	0.3803		0.4082	0.3922		0.4344	0.4032		0.4586	0.4103
	0.3766	0.3765		0.4012	0.3885		0.4282	0.4008		0.4525	0.4087

7. Chromaticity Bins (Continued)

Bin	CIE X	CIE Y	Bin	CIE X	CIE Y	Bin	CIE X	CIE Y	Bin	CIE X	CIE Y
J21	0.3703	0.3726	K21	0.3941	0.3848	L21	0.4221	0.3984	M21	0.4465	0.4071
	0.3766	0.3765		0.4012	0.3885		0.4282	0.4008		0.4525	0.4087
	0.3746	0.3689		0.3982	0.3803		0.4243	0.3921		0.4477	0.3996
	0.3687	0.3652		0.3915	0.3769		0.4184	0.3899		0.4419	0.3982
J22	0.3687	0.3652	K22	0.3915	0.3769	L22	0.4184	0.3899	M22	0.4419	0.3982
	0.3746	0.3689		0.3982	0.3803		0.4243	0.3921		0.4477	0.3996
	0.3727	0.3613		0.3950	0.3721		0.4203	0.3834		0.4428	0.3906
	0.3670	0.3578		0.3889	0.3690		0.4147	0.3814		0.4373	0.3893
J23	0.3766	0.3765	K23	0.4012	0.3885	L23	0.4282	0.4008	M23	0.4525	0.4087
	0.3828	0.3803		0.4082	0.3922		0.4344	0.4032		0.4586	0.4103
	0.3806	0.3725		0.4050	0.3837		0.4302	0.3943		0.4535	0.4011
	0.3746	0.3689		0.3982	0.3803		0.4243	0.3921		0.4477	0.3996
J24	0.3746	0.3689	K24	0.3982	0.3803	L24	0.4243	0.3921	M24	0.4477	0.3996
	0.3806	0.3725		0.4050	0.3837		0.4302	0.3943		0.4535	0.4011
	0.3784	0.3647		0.4017	0.3752		0.4260	0.3853		0.4483	0.3918
	0.3727	0.3613		0.3953	0.3721		0.4203	0.3834		0.4428	0.3906
J31	0.3871	0.3959	K31	0.4146	0.4089	L31	0.4430	0.4212	M31	0.4687	0.4289
	0.3939	0.4002		0.4223	0.4127		0.4496	0.4236		0.4750	0.4304
	0.3915	0.3922		0.4187	0.4040		0.4450	0.4144		0.4697	0.4209
	0.3849	0.3881		0.4114	0.4005		0.4387	0.4122		0.4637	0.4196
J32	0.3849	0.3881	K32	0.4114	0.4005	L32	0.4387	0.4122	M32	0.4637	0.4196
	0.3915	0.3922		0.4187	0.4040		0.4450	0.4144		0.4697	0.4209
	0.3890	0.3842		0.4151	0.3953		0.4404	0.4052		0.4643	0.4115
	0.3828	0.3803		0.4082	0.3922		0.4344	0.4032		0.4586	0.4103
J33	0.3939	0.4002	K33	0.4223	0.4127	L33	0.4496	0.4236	M33	0.4750	0.4304
	0.4006	0.4044		0.4299	0.4165		0.4562	0.4260		0.4813	0.4319
	0.3979	0.3962		0.4260	0.4075		0.4513	0.4166		0.4756	0.4223
	0.3915	0.3922		0.4187	0.4040		0.4450	0.4144		0.4697	0.4209
J34	0.3915	0.3922	K34	0.4187	0.4040	L34	0.4450	0.4144	M34	0.4697	0.4209
	0.3979	0.3962		0.4260	0.4075		0.4513	0.4166		0.4756	0.4223
	0.3952	0.3880		0.4221	0.3984		0.4465	0.4071		0.4700	0.4126
	0.3890	0.3842		0.4151	0.3953		0.4404	0.4052		0.4643	0.4115
J41	0.3828	0.3803	K41	0.4082	0.3922	L41	0.4344	0.4032	M41	0.4586	0.4103
	0.3890	0.3842		0.4151	0.3953		0.4404	0.4052		0.4643	0.4115
	0.3866	0.3762		0.4117	0.3868		0.4360	0.3962		0.4590	0.4023
	0.3806	0.3725		0.4050	0.3837		0.4302	0.3943		0.4535	0.4011
J42	0.3806	0.3725	K42	0.4050	0.3837	L42	0.4302	0.3943	M42	0.4535	0.4011
	0.3866	0.3762		0.4117	0.3868		0.4360	0.3962		0.4590	0.4023
	0.3841	0.3682		0.4082	0.3783		0.4316	0.3873		0.4538	0.3931
	0.3784	0.3647		0.4017	0.3752		0.4260	0.3853		0.4483	0.3918
J43	0.3890	0.3842	K43	0.4151	0.3953	L43	0.4404	0.4052	M43	0.4643	0.4115
	0.3952	0.3880		0.4221	0.3984		0.4465	0.4071		0.4700	0.4126
	0.3925	0.3798		0.4184	0.3899		0.4419	0.3982		0.4646	0.4035
	0.3866	0.3762		0.4117	0.3868		0.4360	0.3962		0.4590	0.4023
J44	0.3866	0.3762	K44	0.4117	0.3868	L44	0.4360	0.3962	M44	0.4590	0.4023
	0.3925	0.3798		0.4184	0.3899		0.4419	0.3982		0.4646	0.4035
	0.3898	0.3716		0.4147	0.3814		0.4373	0.3893		0.4593	0.3944
	0.3841	0.3682		0.4082	0.3783		0.4316	0.3873		0.4538	0.3931

## 8. Typical Characteristic Curves

- Forward Current vs. Forward Voltage

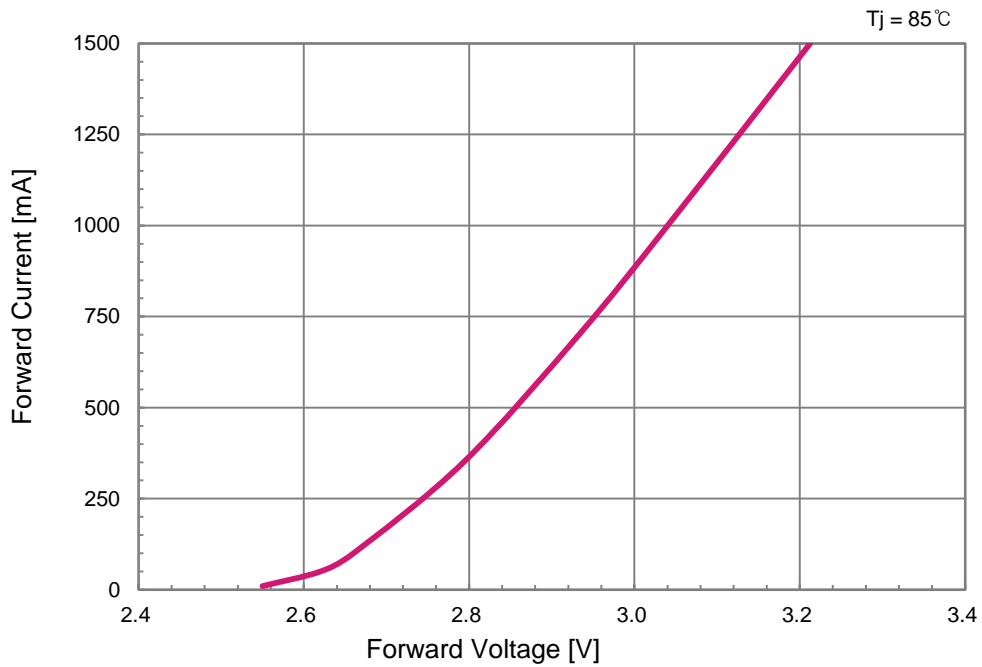

- Relative Luminous Flux vs. Forward Current

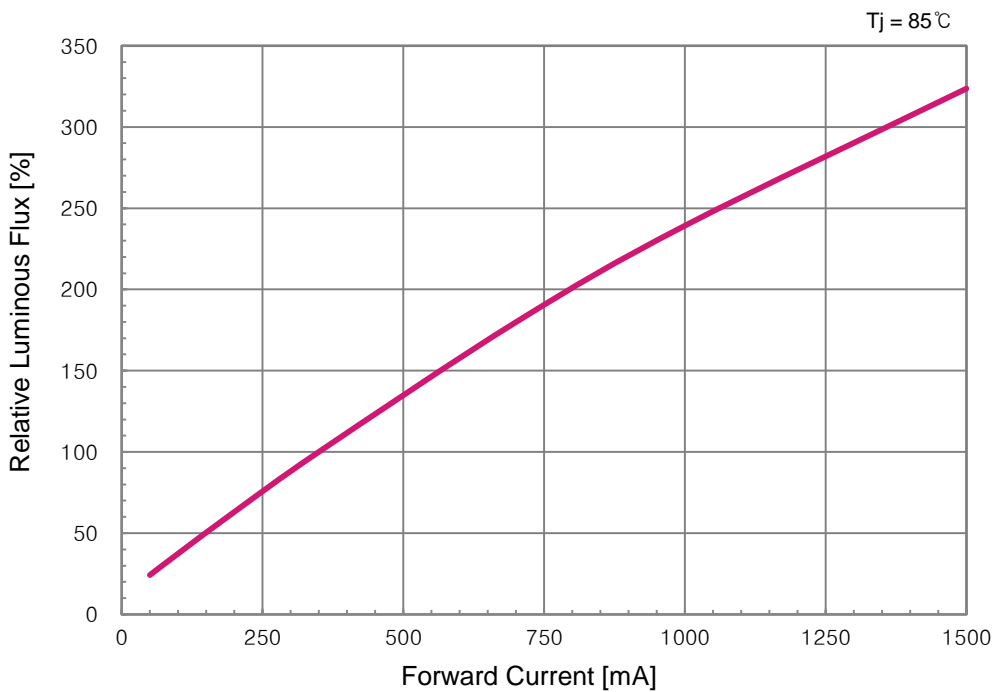

## 8. Typical Characteristic Curves

- Spectrum

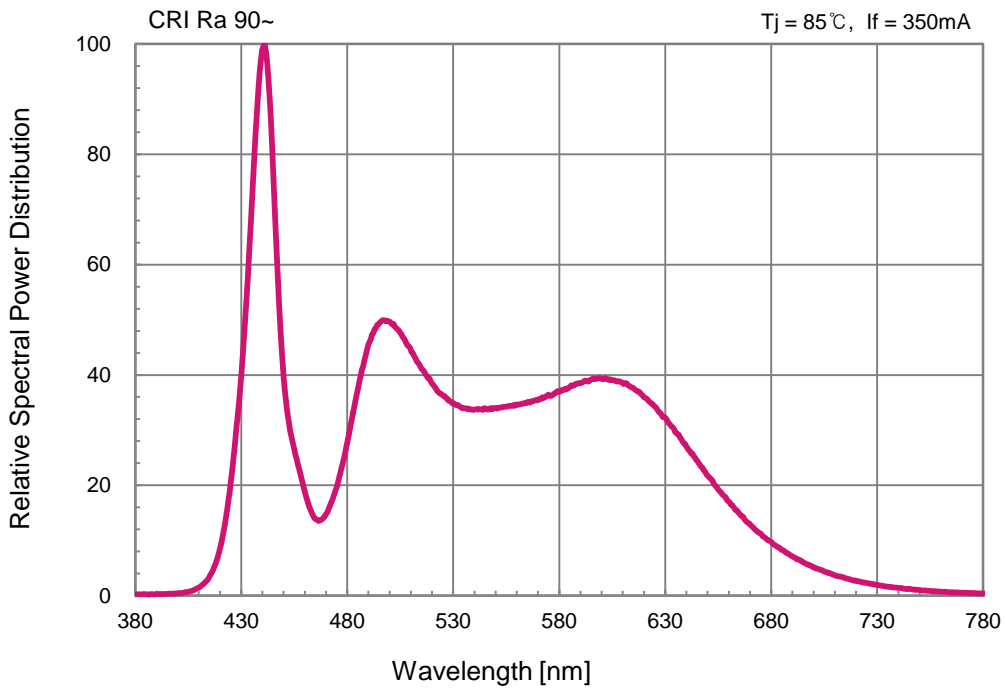
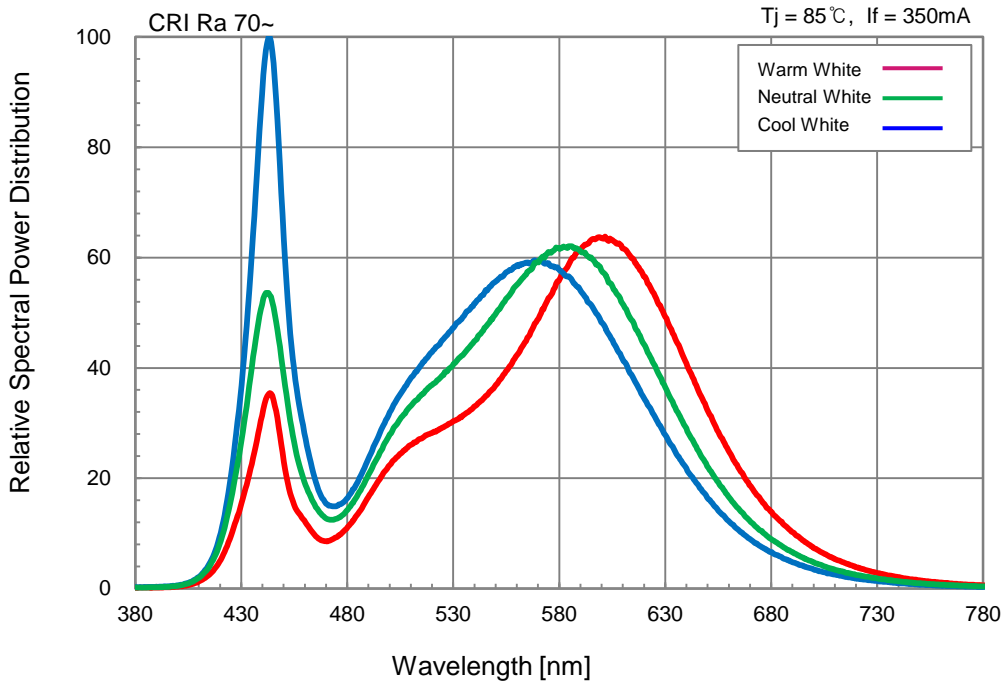

## 8. Typical Characteristic Curves

- Chromaticity Coordinate vs. Forward Current

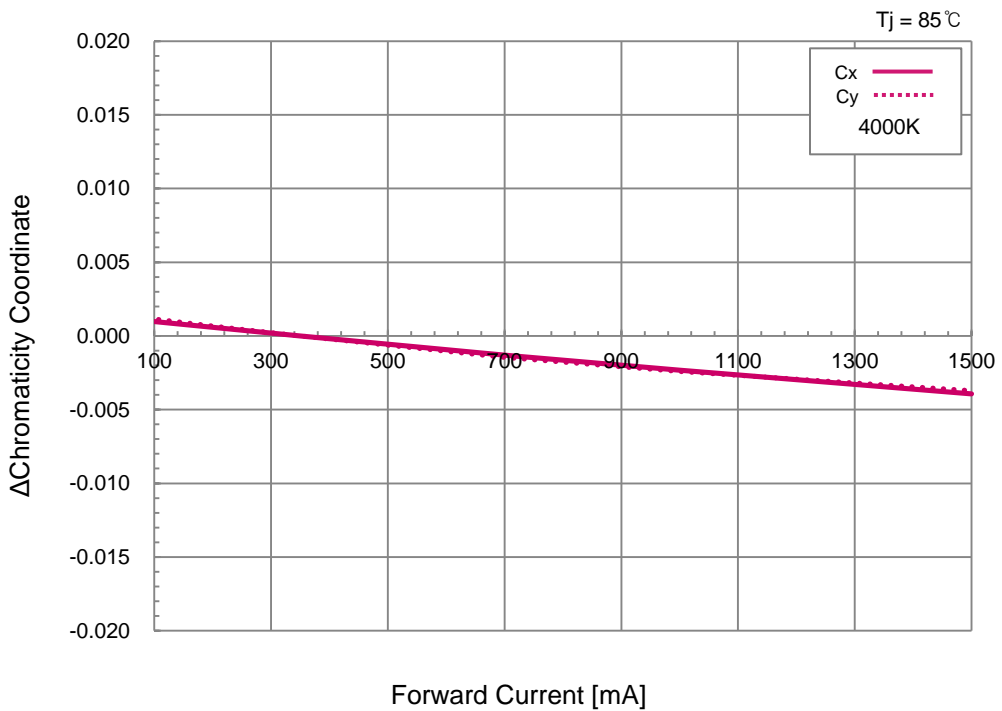
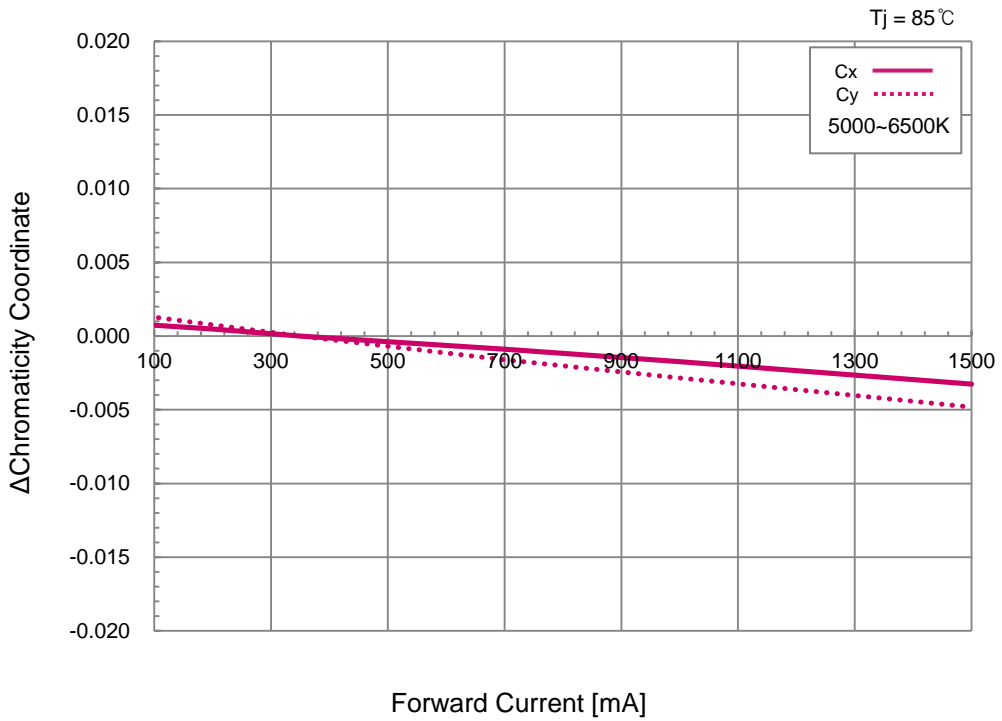

## 8. Typical Characteristic Curves

- Chromaticity Coordinate vs. Forward Current

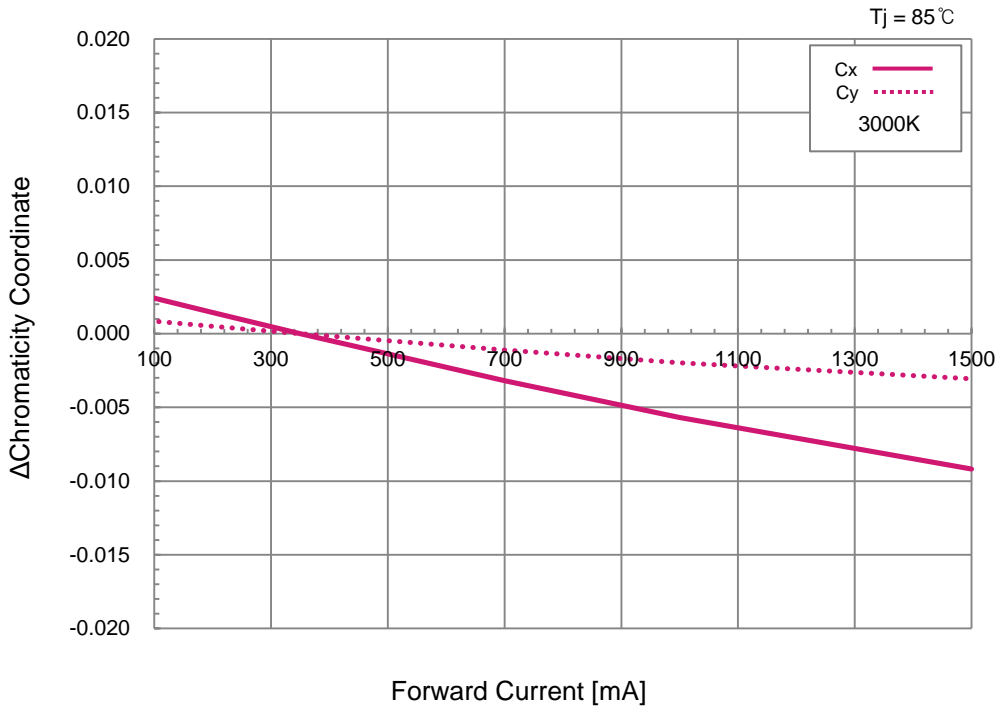

- Luminous Flux vs. Temperature

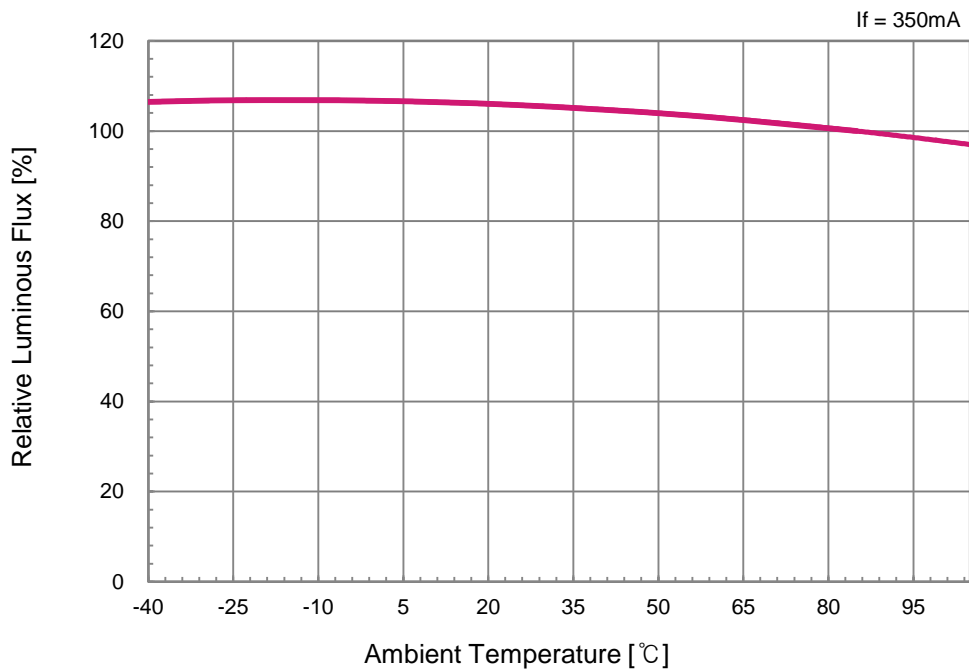

## 8. Typical Characteristic Curves

- Chromaticity Coordinate vs. Temperature

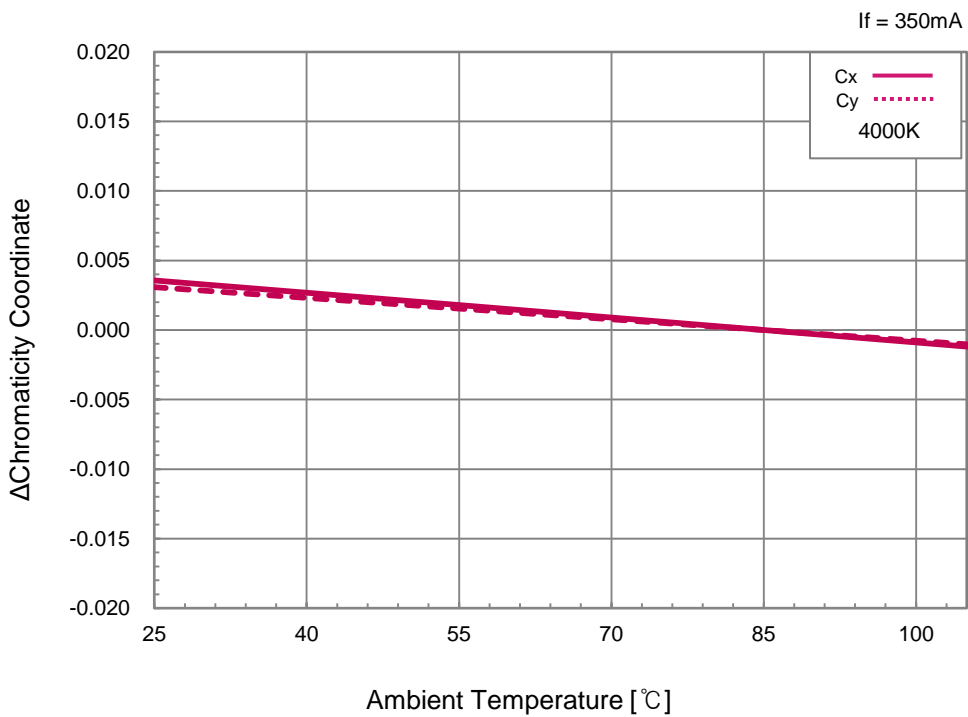
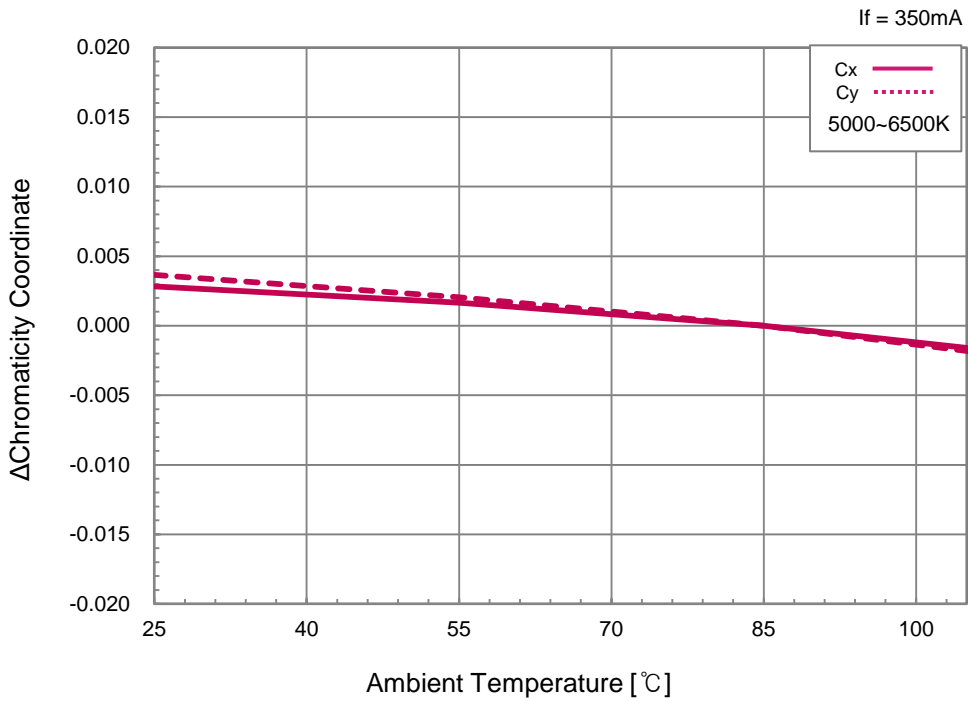



## 8. Typical Characteristic Curves

- Chromaticity Coordinate vs. Temperature

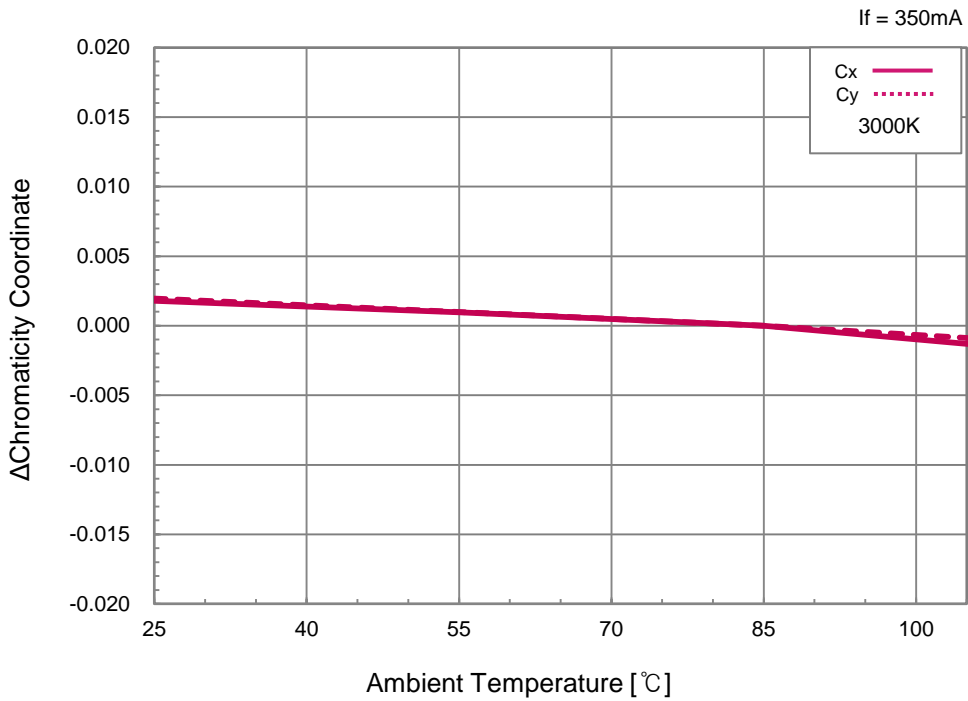

- Forward Voltage vs. Temperature

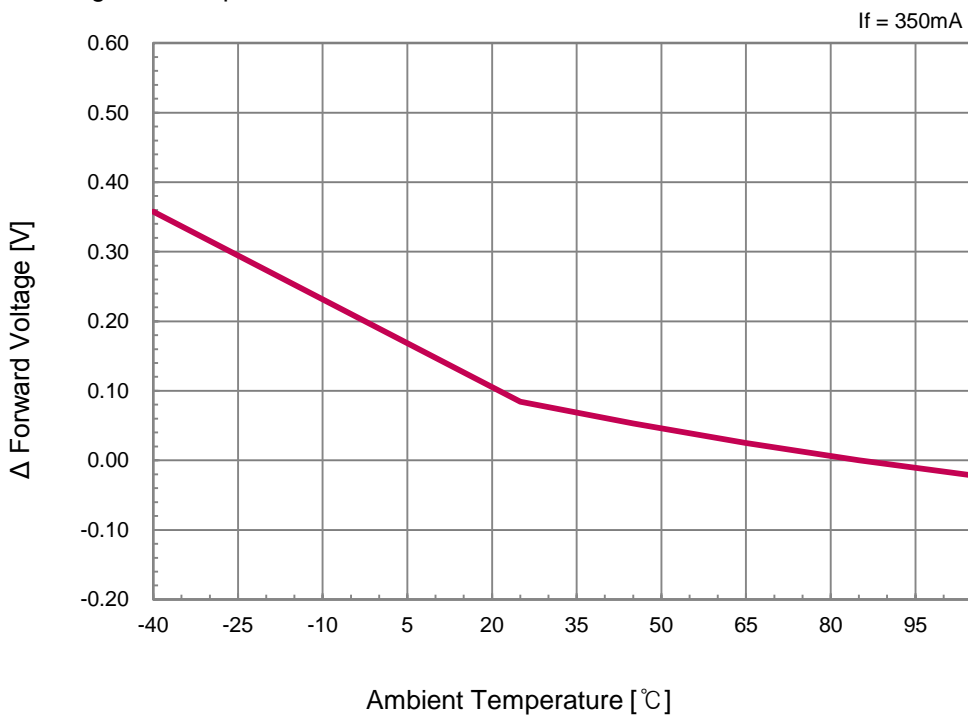

## 8. Typical Characteristic Curves

▪ Radiation Characteristics

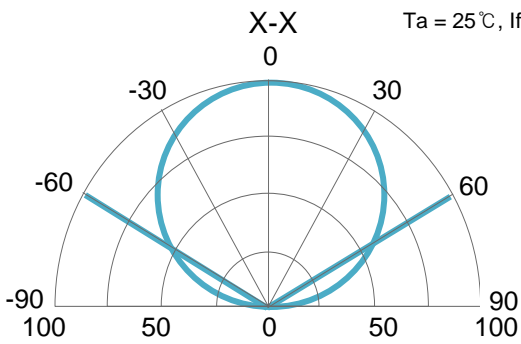

**Cool**

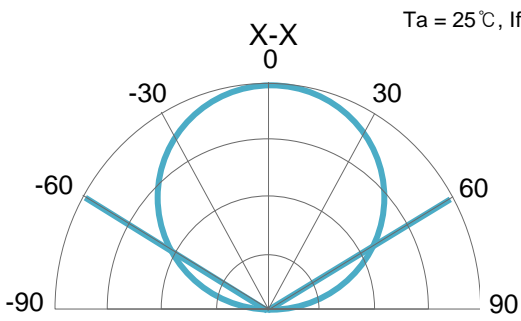
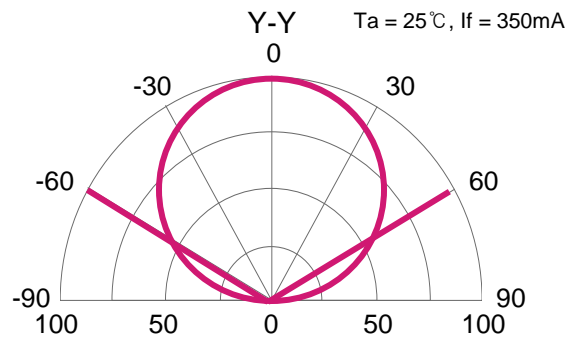

**Neutral**

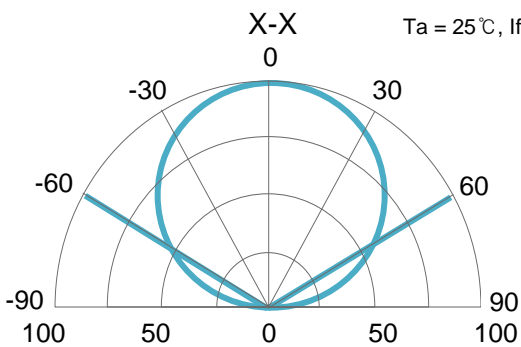
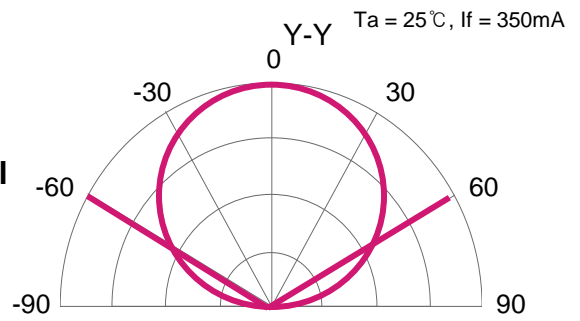

**Warm**

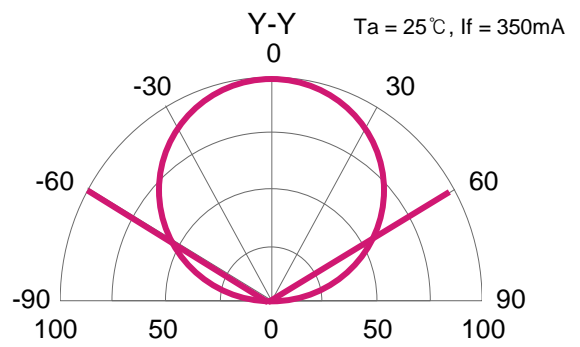

### 8. Typical Characteristic Curves

- Derating Curve

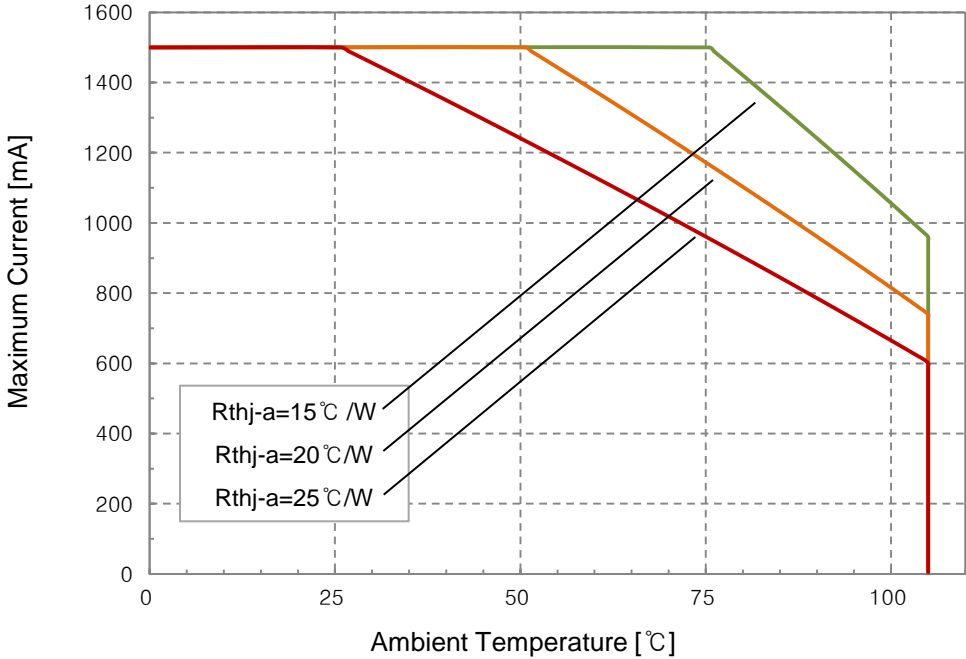

※ The ambient temperature values for each graph are obtained with LG Innotek equipment.

## 9. Reliability Test Items and Conditions

### 9-1. Failure Criteria

Items	Symbol	Test Conditions	Criteria	
			Min.	Max.
Forward Voltage	V <sub>f</sub>	I <sub>f</sub> = 350mA	-	Initial Value × 1.1
Luminous Flux	Φ <sub>v</sub>	I <sub>f</sub> = 350mA	Initial Value × 0.7	-

### 9-2. Reliability Tests

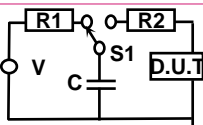
No	Items	Test Conditions	Test Hours /Cycles	Sample Size	Ac/Re
1	Room Temperature Operating Life (RTOL)	T <sub>a</sub> = 25 °C, I <sub>f</sub> = 1,500mA	1,000 Hours	11 pcs	0/1
2	Wet High Temperature Operating Life (WHTOL)	T <sub>a</sub> = 85 °C, RH = 85% I <sub>f</sub> = 1,000mA	500 Hours	11 pcs	0/1
3	High Temperature Operating Life (HTOL)	T <sub>a</sub> = 85 °C, I <sub>f</sub> = 1,000mA	1,000 Hours	11 pcs	0/1
4	Low Temperature Operating Life (LTOL)	T <sub>a</sub> = -40 °C, I <sub>f</sub> = 1,000mA	1,000 Hours	11 pcs	0/1
5	High Temperature Storage Life (HTSL)	T <sub>a</sub> = 125 °C	1,000 Hours	11 pcs	0/1
6	Low Temperature Storage Life (LTSL)	T <sub>a</sub> = -40 °C	1,000 Hours	11 pcs	0/1
7	Wet High Temperature Storage Life (WHTSL)	T <sub>a</sub> = 85 °C, RH = 85%	1,000 Hours	11 pcs	0/1
8	Temperature Cycle (TC)	-40 °C (30min) ~ 100 °C (30min)	100 Cycles	11 pcs	0/1
9	Moisture Sensitivity Level (MSL)	T <sub>slid</sub> = 260 °C (Pre treatment 60 °C, 60% 168 hours)	3 Times	11 pcs	0/1
10	Electrostatic Discharge Test Voltage 8kV (HBM)	 R1 : 10MΩ, R2 : 1.5kΩ, C : 100pF	3 Times	11 pcs	0/1
11	Vibration	100~2000~100Hz Sweep 4min. 200m/s <sup>2</sup> , 3 directions, 4Cycles	48 Minutes	20 pcs	0/1

※ All samples are tested using LG Innotek Standard Metal PCB (25x25x1.6 mm<sup>3</sup>(L×W×H)) except MSL test .

※ All samples must pass each test item and all test items must be satisfied.

## 10. Packing and Labeling of Products

### 10-1. Taping Outline Dimensions

#### Reel

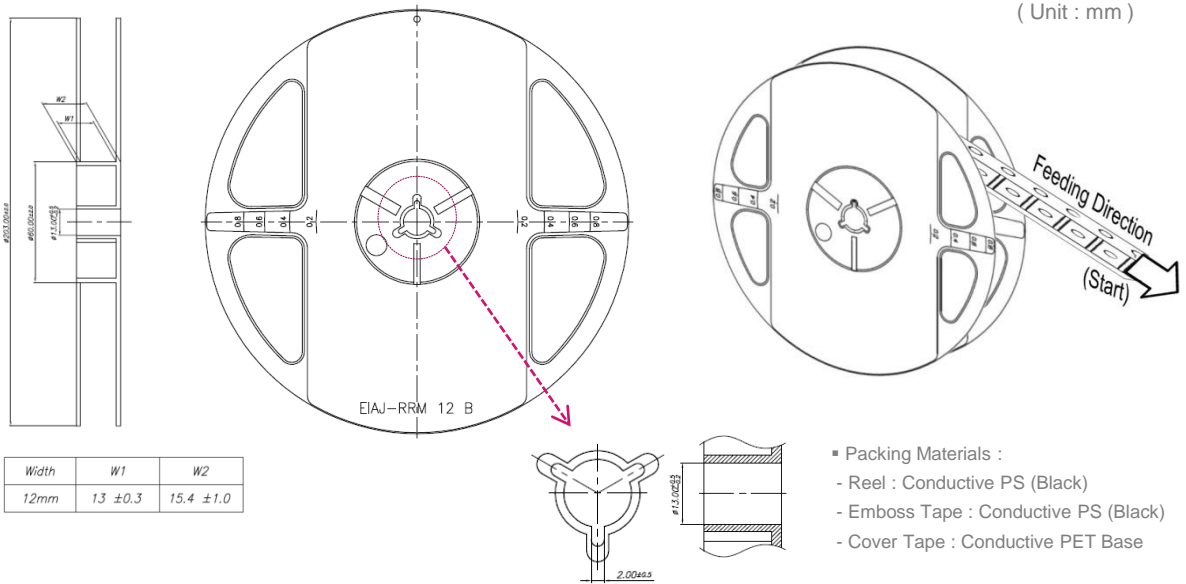

#### Tape

Polarity Direction in Pocket

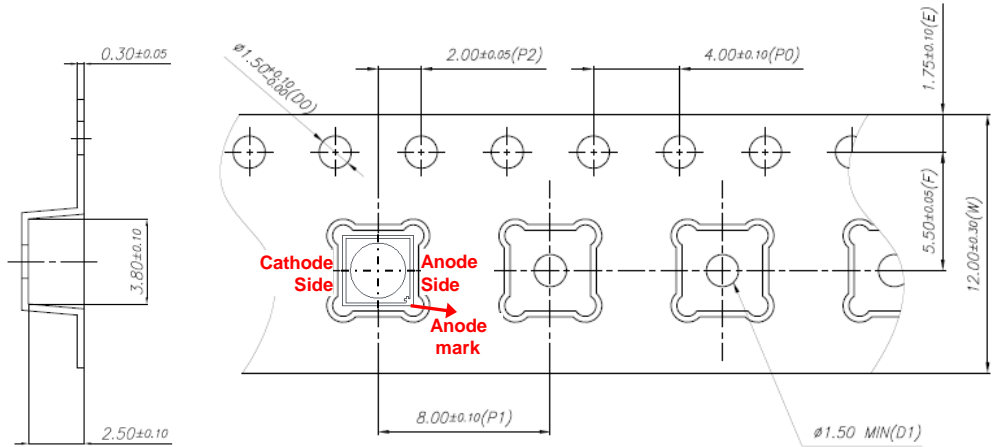
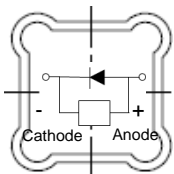

#### Taping Arrangement

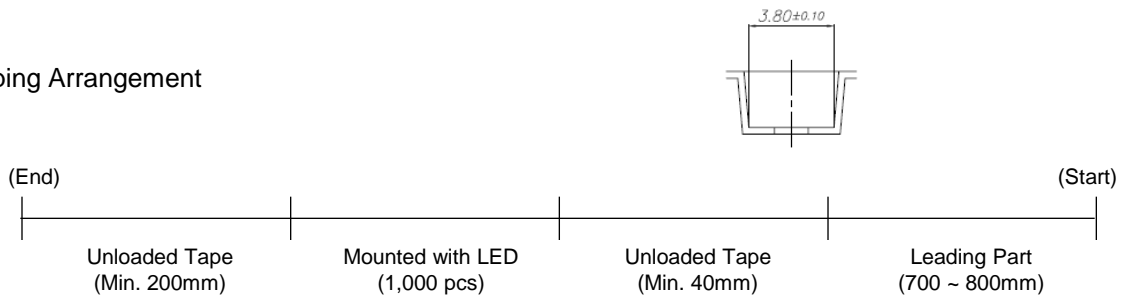

## 10. Packing and Labeling of Products

### 10-2. Label Structure

#### ※. Label A

Specifying 'Lot ID', 'Model Name', 'MES ID', 'RANK', 'Q'ty', 'Run No', 'Rack No.'

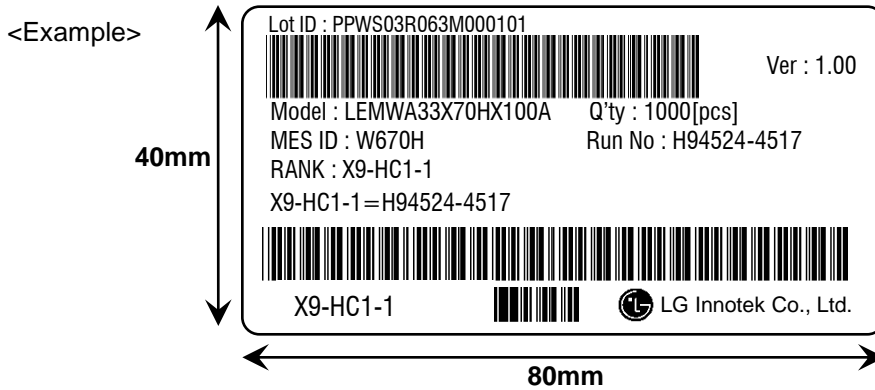

#### ▪ Run No. indication

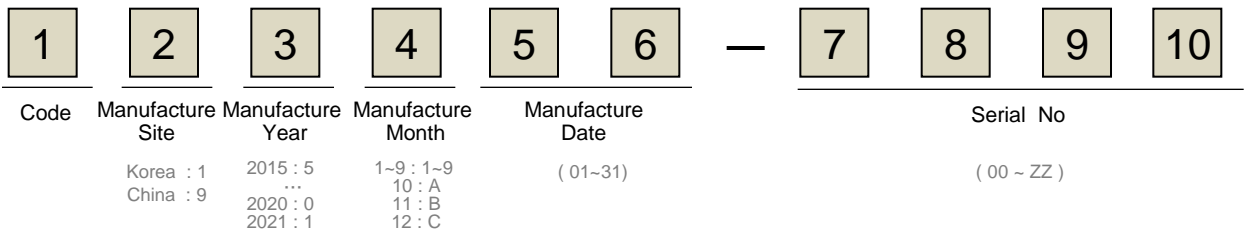

## 10. Packing and Labeling of Products

### 10-2. Label Structure

#### ※. Label C

Specifying 'Customer', 'Date', 'Model Name', 'Quantity', 'Customer Part no', 'Outbox ID', 'LGIT Internal Model Name'

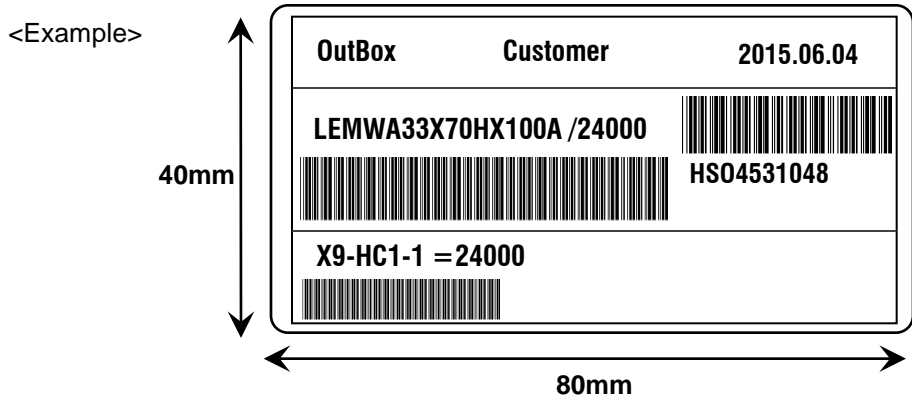

#### ▪ Box ID. indication

1	2	3	4	5	6	7	8	9	10
Manufacture Site	PKG Site	Box	Year	Month	Date		Serial No		
			2015 : 5 ...	1~9 : 1~9 10 : A 11 : B 12 : C	( 01 ~ 31 )		( 001 ~ 999 )		
Paju : P Huizhou : H	PKG : S, P	Inner Box : I Outer Box : O	2020 : 0 2021 : 1						

## 10. Packing and Labeling of Products

### 10-3. Packing Structures

Reeled products (Numbers of products are Max. 1,000 pcs) packed in a sealed-off and moisture-proof aluminum bag with desiccants (Silica Gel). Maximum four aluminum bags are packed in an inner box and six inner boxes are packed in an outer box. (Total Max. number of products are 24,000 pcs)

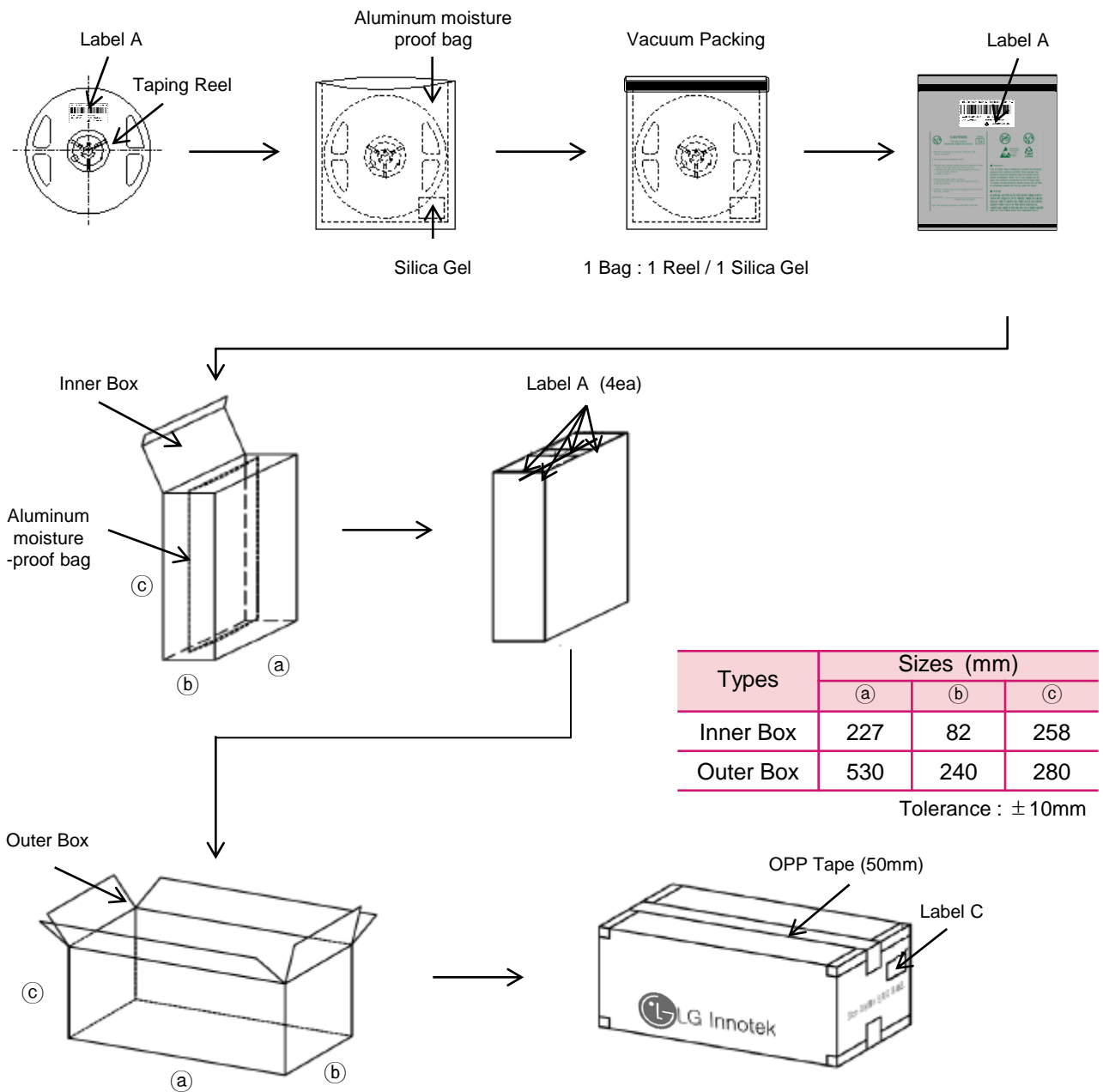



## 11. Cautions on Use

### 11-1. Moisture-Proof Package

- The moisture in the SMD package may vaporize and expand during soldering.
- The moisture can damage the optical characteristics of the LEDs due to the encapsulation.

### 11-2. During Storage

Conditions		Temperature	Humidity	Time
Storage	Before Opening Aluminum Bag	5°C ~ 30°C	< 50%RH	Within 1 Year from the Delivery Date
	After Opening Aluminum Bag	5°C ~ 30°C	< 60%RH	≤ 672 hours
Baking		65 ± 5°C	< 10%RH	10 ~ 24 hours

- The LEDs should be stored in a clean environment. If the LEDs are stored for 3 months or more after being shipped from LGIT, a sealed container with a nitrogen gas should be used for storage.
- When storing the LEDs after opening aluminum bag, reseal with a moisture absorbent material inside

### 11-3. During Usage

- The LED should be avoided direct contact with hazardous materials such as sulfur, chlorine, phthalate, acid, solvent, etc. These materials(S, Cl, VOCs, etc) may cause sulfurization of silver lead-frame or encapsulant silicone discoloration in LED.  
VOCs(Volatile Organic Compounds) can be generated from adhesives glue, cleaning flux, molding hardener or organic additive which used in luminaires fixtures and they(VOCs) may cause a significant lumen degradation of LED in luminaires when they exposed to heat or light.  
To prevent this phenomenon, materials used in luminaires must be carefully selected by users.
- The metal parts on the LED can rust when exposed to corrosive gases. Therefore, exposure to corrosive gases must be avoided during operation and storage.
- The metal parts also can be affected not only by the corrosive gases emitted inside of the end-products but by the gases penetrated from outside environment.
- Extreme environments such as sudden ambient temperature changes or high humidity that can cause condensation must be avoided.

### 11-4. Cleaning

- Do not use brushes for cleaning or organic solvents (i.e. Acetone, TCE, etc..) for washing as they may damage the resin of the LEDs.
- Isopropyl Alcohol(IPA) is the recommended solvent for cleaning the LEDs under the following conditions. Cleaning Condition : IPA, 25°C max. × 60sec max.
- Ultrasonic cleaning is not recommended. Pretests should be conducted with the actual cleaning process to validate that the process will not damage the LEDs.

## 11. Cautions on Use

### 11-5. Thermal Management

- The thermal design of the end product must be seriously considered, particularly at the beginning of the system design process.
- The generation of heat is greatly impacted by the input power, the thermal resistance of the circuit boards and the density of the LED array combined with other components.

### 11-6. Static Electricity

- Wristbands and anti-electrostatic gloves are strongly recommended and all devices, equipment and machinery must be properly grounded when handling the LEDs, which are sensitive against static electricity and surge.
- Precautions are to be taken against surge voltage to the equipment that mounts the LEDs.
- Unusual characteristics such as significant increase of current leakage, decrease of turn-on voltage, or non-operation at a low current can occur when the LED is damaged.

### 11-7. Recommended Circuit

- The current through each LED must not exceed the absolute maximum rating when designing the circuits.
- In general, there can be various forward voltages for LEDs. Different forward voltages in parallel via a single resistor can result in different forward currents to each LED, which also can output different luminous flux values. In the worst case, the currents can exceed the absolute maximum ratings which can stress the LEDs. Matrix circuit with a single resistor for each LED is recommended to avoid the luminous flux fluctuations.

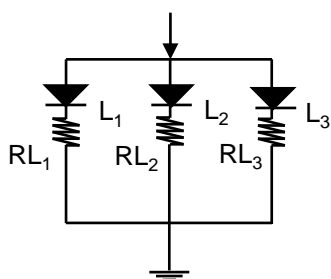

Fig.1 Recommended Circuit in Parallel Mode  
: Separate resistors must be used for each LED.

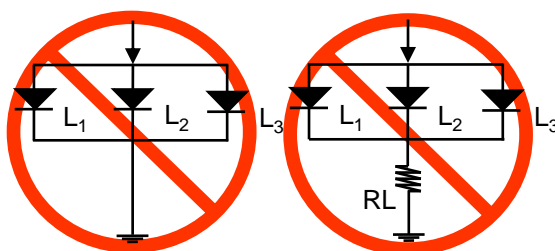

Fig.2 Abnormal Circuit  
Circuits to Avoid : The current through the LEDs may vary due to the variation in LED forward voltage.

- The driving circuits must be designed to operate the LEDs by forward bias only.
- Reverse voltages can damage the zener diode, which can cause the LED to fail.
- A constant current LED driver is recommended to power the LEDs.

## 11. Cautions on Use

### 11-8. Soldering Conditions

- Reflow soldering is the recommended method for assembling LEDs on a circuit board.
- LG Innotek does not guarantee the performance of the LEDs assembled by the dip soldering method.
- Recommended Soldering Profile (according to JEDEC J-STD-020D)

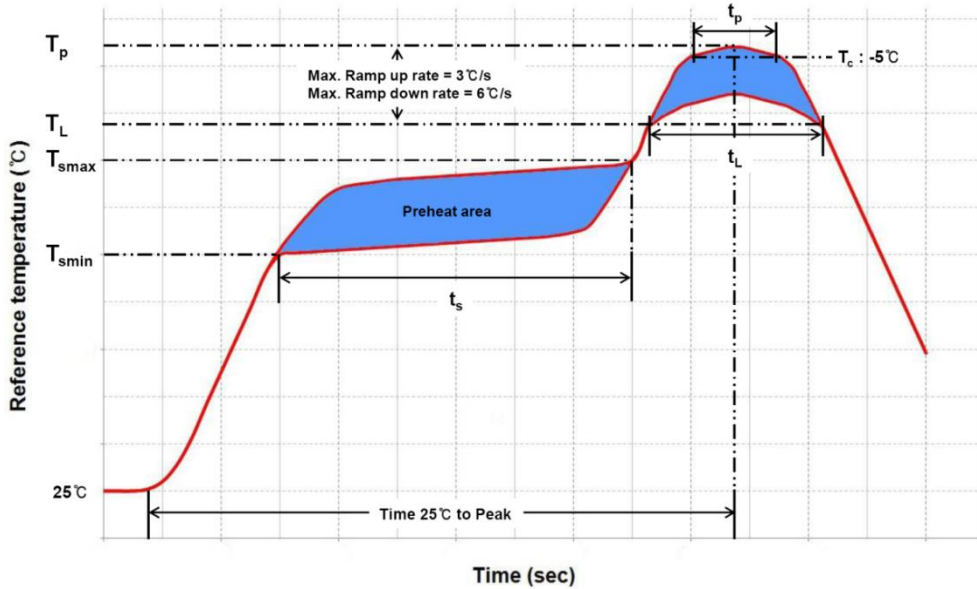

Profile Feature	Pb-Free Assembly	Pb-Based Assembly
Preheat / Soak		
Temperature Min ( $T_{smin}$ )	150°C	100°C
Temperature Max ( $T_{smax}$ )	200°C	150°C
Maximum time ( $t_s$ ) from $T_{smin}$ to $T_{smax}$	60~120 seconds	60~120 seconds
Ramp-up rate ( $T_L$ to $T_p$ )	3°C/ second max.	3°C/ second max.
Liquidus temperature ( $T_L$ )	217°C	183°C
Time ( $t_L$ ) maintained above $T_L$	60~150 seconds	60~150 seconds
Maximum peak package body temperature ( $T_p$ )	260°C	235°C
Time ( $t_p$ ) within 5°C of the specified temperature ( $T_c$ )	30 seconds	20 seconds
Ramp-down rate ( $T_p$ to $T_L$ )	6°C/second max.	6°C/second max.
Maximum Time 25°C to peak temperature	8 minutes max.	6 minutes max.

- Reflow or hand soldering at the lowest possible temperature is desirable for the LEDs although the recommended soldering conditions are specified in the above diagrams.
- A rapid cooling process is not recommended for the LEDs from the peak temperature.
- The silicone encapsulant at the top of the LED package is a soft surface, which can easily be damaged by pressure. Precautions should be taken to avoid strong pressure on the silicone resin when leveraging the pick and place machines.
- Reflow soldering should not be done more than two times.

## 11. Cautions on Use

### 11-9. Soldering Iron

- The recommended condition is less than 5 seconds at 260 °C.
- The time must be shorter for higher temperatures. (+10 °C → -1sec).
- The power dissipation of the soldering iron should be lower than 15W and the surface temperature of the device should be controlled at or under 230 °C.

### 11-10. Eye Safety Guidelines

- Do not directly look at the light when the LEDs are on.
- Proceed with caution to avoid the risk of damage to the eyes when examining the LEDs with optical instruments.

### 11-11. Manual Handling

- Use Teflon-type tweezers to grab the base of the LED and do not apply mechanical pressure on the surface of the encapsulant.

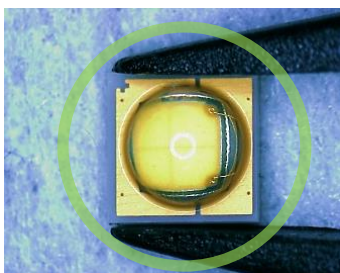

## 12. Disclaimers

- LG Innotek is not responsible for any damages or accidents caused if the operating or storage conditions exceed the absolute maximum ratings recommended in this document.
- The LEDs described in this document are intended to be operated by ordinary electronic equipment.
- The LEDs should not be used at any lighting products together with the other LEDs, which has a different part number. If required, please contact any sales person.
- It is recommended to consult with LG Innotek when the environment or the LED operation is non-standard in order to avoid any possible malfunctions or damage to product or risk of life or health.
- Disassembly of the LED products for the purpose of reverse engineering is prohibited without prior written consent from LG Innotek. All defected LEDs must be reported to LG Innotek and are not to be disassembled or analyzed.
- The product information can be modified and upgraded without prior notice.

## 13. Package Nomenclature

All LEDs are tested and sorted by color, luminous flux and forward voltage where every LED in a tube has only a single color bin, luminous flux bin and forward voltage bin. However, the forward voltage bin information is not captured in the part number nomenclature.

A 16-digit part number is required when orders are placed. LG Innotek leverages the following part number nomenclature.

